

Product Engineering Guide

ZIP Module 7012A

Introduction

With the decrease of large programmable controllers and the increase of 'fixed function' controllers being used in buildings there is a growing need for a cost effective way of picking up extra inputs and outputs. ZIP is a modular data acquisition system. It is designed to operate either within a control panel or stand-alone.

A 'ZIP System' is a collective term for the connection of ZIP Modules, ZIPNet, and a ZIPMaster. Some ZIP Modules link together in a 'daisy chain' style using PowerZIP connectors. One of the modules in the 'daisy chain' is the M7012A.

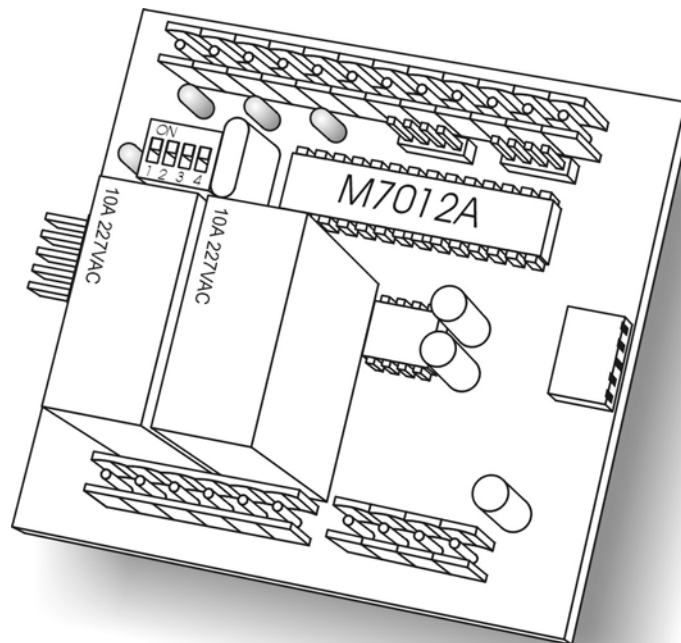

(87mm x 72mm)

ZIP M7012A

The ZIP M7012A is a 3 Digital / 2 Analogue Input, 2 Digital / 2 Analogue Output module. When the module is connected with power running through it, the green LED beside the Address Switch should be permanently on or flashing. The flashing shows the module is working properly, and as soon as the master has started to communicate with the module the LED will remain continuously lit.

Engineering

Step 1 – Power down ZIP System

Before connecting the ZIP M7012A to the ZIPNet, turn off the power to the Zip System.

Step 2 – Set the ZIP Module's Address

Set the ZIP Module's unique address using the Address Switch. The address of a module must be in the range of 0-15.

Step 3 – Connecting the 12V power supply

Connect a 12VDC @ 1A power supply to one side of the ZIP M7012A. See section **'Power Supply and Network'**

Step 4 – Connecting the ZIP Net

Using the appropriate cable connect the ZIP M7012A to your ZIPMaster. See section **'Power Supply and Network'**

Step 5 – Connect External Hardware

Connect the required inputs / outputs to the Zip Module.

Step 6 – Power up ZIP System, including the M7012A

When power is re-applied, the green LED beside the address switch should flash on and off to show the module is working properly. As soon as the master is communicating with the module, the LED will remain continuously lit. If the module fails to communicate with the master the LED will continue to flash.

Step 7 – Object Engineering

Use object-engineering software to access your ZIPMaster and set up the objects within the M7012A.

For greater detail see the relative sections in **'M7012A Objects'**.

Data from your ZIP Module can now be accessed to test that it is functioning correctly.

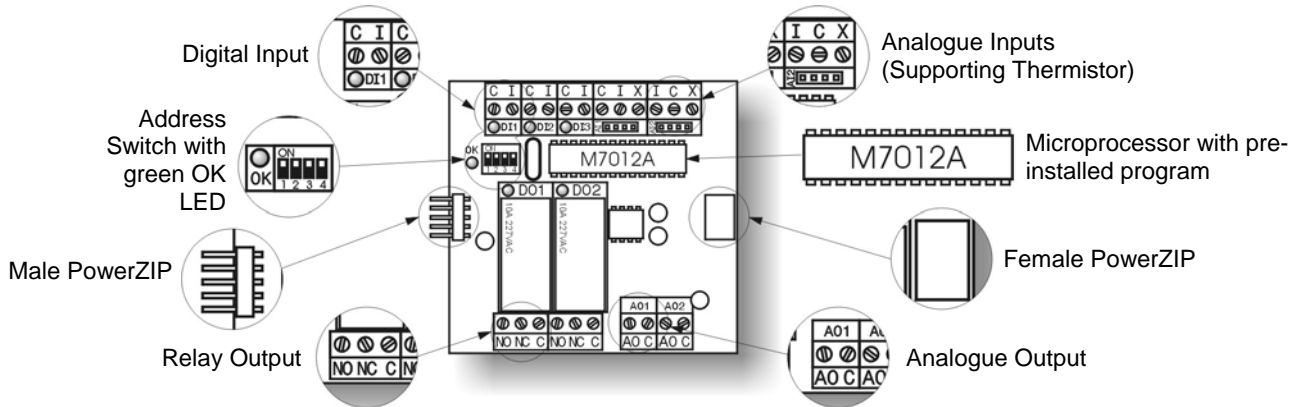

Address Switch

The Address Switch allows the module address to be set. There are 16 different addresses available, set with different combinations of the 4 switches labelled 1 to 4. Up is on and down is off.

Module Address	Switch Position			
	1	2	3	4
0	Off	Off	Off	Off
1	On	Off	Off	Off
2	Off	On	Off	Off
3	On	On	Off	Off
4	Off	Off	On	Off
5	On	Off	On	Off
6	Off	On	On	Off
7	On	On	On	Off

Module Address	Switch Position			
	1	2	3	4
8	Off	Off	Off	On
9	On	Off	Off	On
10	Off	On	Off	On
11	On	On	Off	On
12	Off	Off	On	On
13	On	Off	On	On
14	Off	On	On	On
15	On	On	On	On

Examples



With the Address Switch set with 1=on, 2=off, 3=on, 4=off, the modules address will be 5.



With the Address Switch set with 1=on, 2=off, 3=off, 4=on, the modules address will be 9.

Power Supply and Network

The ZIP M7012A must have a power supply of 12VDC @ 1A, which can be connected from either side. The 12V-power supply can also be linked to further ZIP M7012A or ZIP NetCards on the ZIPNet, but each card must have 1A.

Like the power supply, the ZIPNet from the ZipMaster can be connected from either side. The last ZIP module on the ZIPNet may require a terminator of 125ohms that across the network connectors.

With the ZIPNet having a maximum length of 1000m, ZIP modules can have different 12V power supplies. The ZIP M7012A's ZIPNet is isolated, simplifying power supply selection.

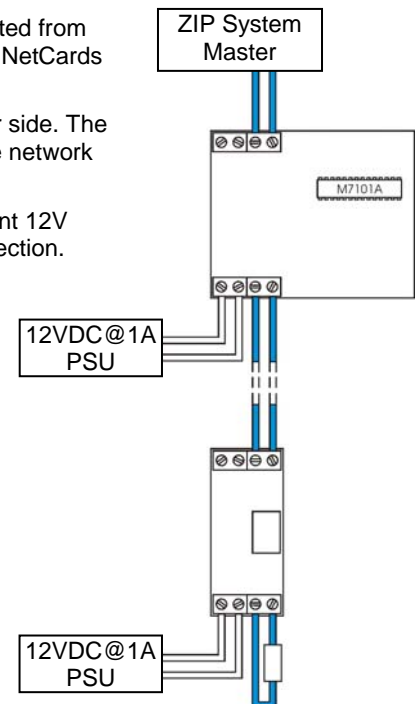

M7012A Objects

Once the M7012A has been correctly wired in to the module and the 12VDC power has been connected to the ZIP System, access your ZIP Master using Object Engineering software and set up the objects within the M7012A.

Digital Inputs

The 3 digital-inputs are labelled DI1...DI3.

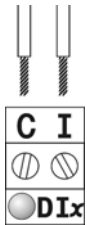

Each digital input is design to connect directly to a volt-free switch. The input reads 'off' when the switch is open, and on when the switch is closed. The digital input's red LED is lit when the input is 'on'. The two terminals are labelled:

- C 'common'
- I 'input'

Below are examples of volt-free switches that a digital input could be wired to.



A simple switch - when in the open position the digital input's red LED is off.

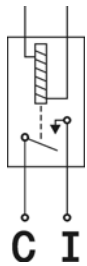

A relay - when not energised the digital input's red LED is off.

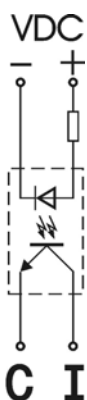

An Optocoupler - isolates the digital input from external power supplies.

Analogue Inputs (0-20mA)

The two Analogue inputs are labelled AI1...AI2. Each Analogue input is designed to be configurable. To set the analogue input to measure a 0-20mA voltage place the jumper on the two pins on the left.

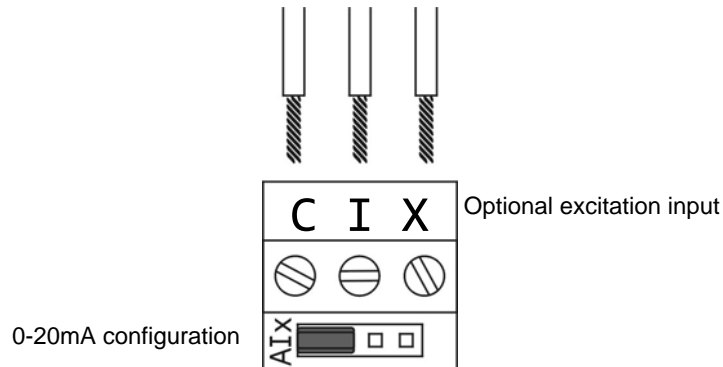

When the jumper is in the 20mA position the internal connections are shown below.

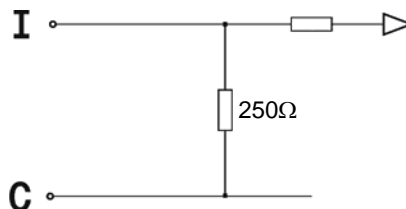

The three terminals on each Analogue input are labelled:

- X 'Excitation'
- I 'input' (configurable, see diagrams below)
- C 'common'

Certain sensors require 'exciting' for them to operate. The exciting of the sensor should not be confused with applying power. When a sensor requires power to operate it can be supplied either from the ZIP module or the sensor should have its own power supply.

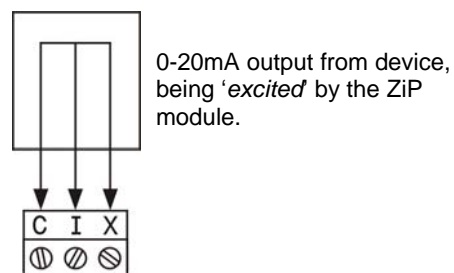

Within the ZIPMaster, the 'Scale 0' reading/value and 'Scale 1' reading/value are used to rescale the 'Input Reading' to produce useful engineering units.

Analogue Inputs (0-5V)

The two Analogue inputs are labelled AI1...AI2. Each Analogue input is design to be configurable. To set the analogue input to measure a 0-5V voltage place the jumper on the centre two pins.

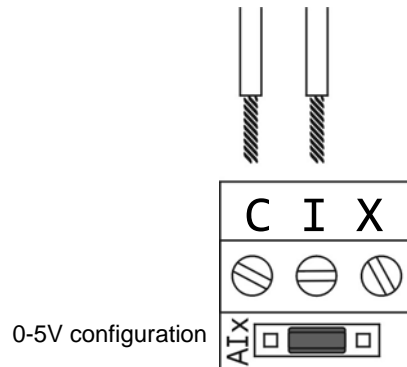

When the jumper is in the 5V position internal connections are shown below

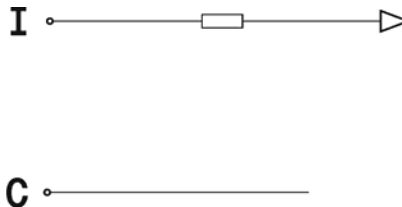

The three terminals on each Analogue input are labelled:

- X 'Excitation'
- I 'input' (configurable, see diagrams below)
- C 'common'

Certain sensors require 'exciting' (or powering) for them to operate. There is a small amount of regulated power available at the X connector, or you may use external power supplies. If external power supplies are used, ensure that they share the same OV level with the C connector, or use isolation devices.

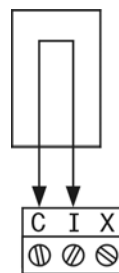

Within the ZIPMaster, the 'Scale 0' reading/value and 'Scale 1' reading/value are used to rescale the 'Input Reading' to produce useful engineering units.

Analogue Inputs (0-10V)

The 2 Analogue inputs are labelled AI1...AI2. Each Analogue input is design to be configurable. To set the analogue input to measure a 0-10V voltage place the jumper on the two pins on the right.

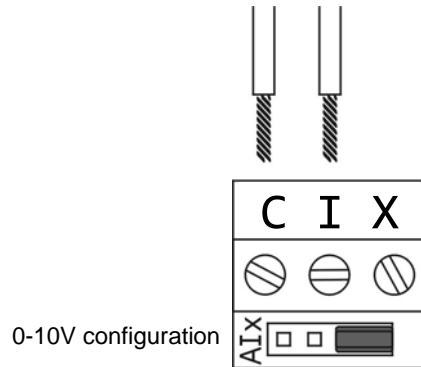

When the jumper is in the 10V position internal connections are shown below

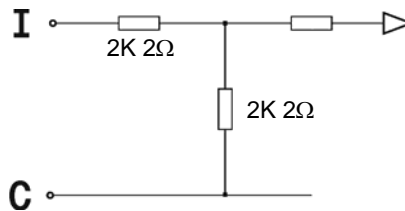

The three terminals on each Analogue input are labelled:

- X 'Excitation'
- I 'input' (configurable, see diagrams below)
- C 'common'

Certain sensors require 'exciting' (or powering) for them to operate. There is a small amount of regulated power available at the X connector, or you may use external power supplies. If external power supplies are used, ensure that they share the same OV level with the C connector, or use isolation devices.

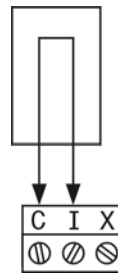

Within the ZIPMaster, the 'Scale 0' reading/value and 'Scale 1' reading/value are used to rescale the 'Input Reading' to produce useful engineering units.

Thermistor Inputs (10K3A)

The two Analogue inputs are labelled AI1...AI2. Each Analogue input is design to be configurable. To set the analogue input to measure a Thermistor place the jumper on the centre two pins.(as per 0-5V setting)

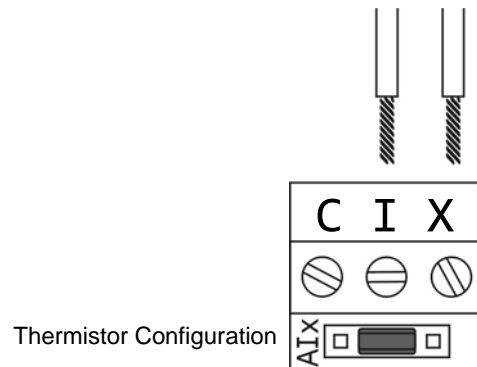

When the jumper is in the Thermistor (5V) position internal connections are shown below

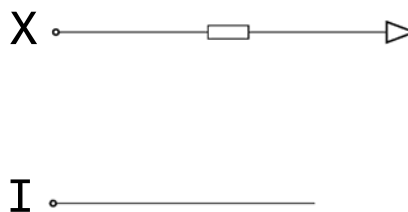

The three terminals on each Analogue input are labelled:

- X 'Excitation'
- I 'input' (configurable, see diagrams below)
- C 'common'

Certain sensors require 'exciting' (or powering) for them to operate. There is a small amount of regulated power available at the X connector, or you may use external power supplies. If external power supplies are used, ensure that they share the same 0V level with the C connector, or use isolation devices.

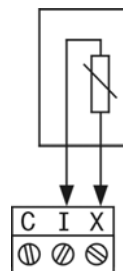

The ZIPMaster takes the input value from the thermistor and calculates the value into a useful engineering unit, (C°)

Digital Outputs

The two relay outputs are labelled as DO1...DO2.



The relay is capable of handling 277VAC @10A or 28VDC @10A. Each output has a red LED that is lit when the output is on. The three terminals are labelled:

- NO 'normally open'
- C 'common'
- NC 'normally closed'

The example below shows the wiring of a bulb to the relay's Normally Closed (NC) and Common (C) output terminals.

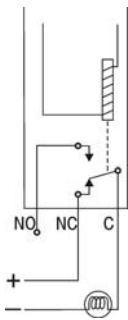

When the relay is not energised the 'normally closed' and 'common' will be connected completing the circuit. The relays LED is off.

The example below shows the wiring of a bulb to the relay's Normally Open (NO) and Common (C) output terminals.

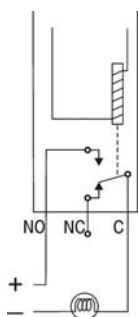

When the relay is energised the 'normally open' and 'common' will be connected completing the circuit. The relays LED will be on.

Analogue Outputs

The two analogue outputs are labelled as AO1...AO2.

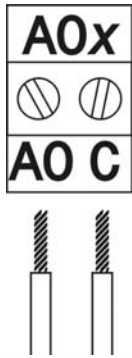

The output is in the range of 0V to 10V:

- AO 'analogue output'
- C 'common'

The analogue output on a ZiP module is only to be used as a voltage signal and should not be used as an adjustable power supply.